

Piezas de repuesto y componentes

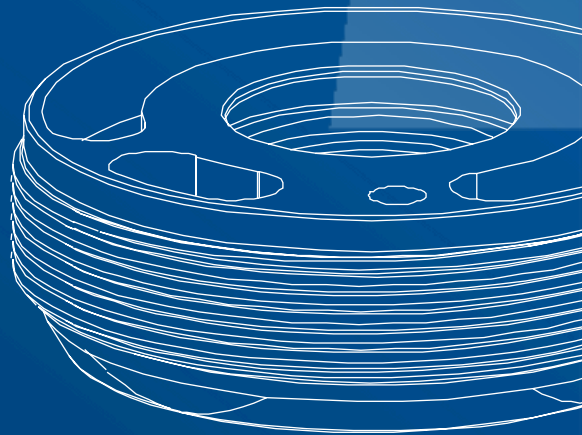
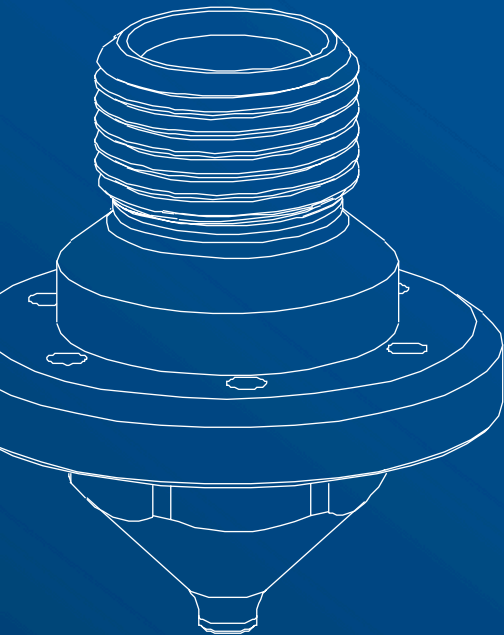

REPUESTOS

LISTA DE ELEMENTOS DE DETALLE

mod. MG

- 1007-2** [x1] Boquilla
- 1007-S** [x2] Junta
- 1286-D1** [x1] Cuerpo
- 1286-D2** [x1] Casquillo
- 1286-D4-M0** [x1] Cabeza
- 1286-D4-M1** [x1] Cabeza
- 1286-D5** [x1] Varilla
- 1286-D6** [x1] Tapa
- 1286-D8** [x1] Émbolo
- 1286-D10** [x1] Tapa
- 1286-D11** [x1] Volante
- 1286-D12** [x1] Puntera
- 1286-D13** [x1] Anillo
- 1303-75-X** [x1] Resorte
- 1286-M2** [x1] Resorte
- 1303-75-X** [x1] Resorte
- O5** [x1] Junta
- R22** [x3] Unión
- S2** [x1] Tapón

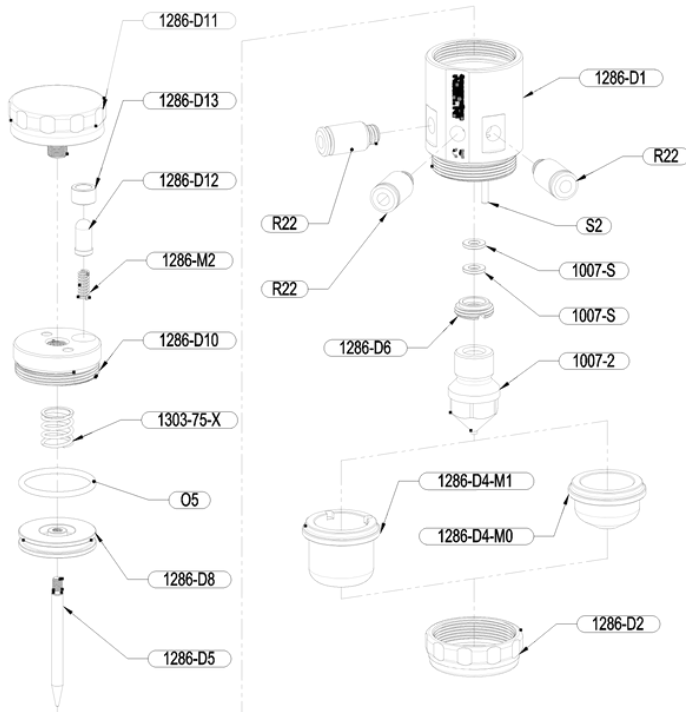

NOTA

Consulte la tabla CNN que aparece a continuación, para conocer las cabezas compatibles con su modelo.

REPUESTOS

LISTA DE ELEMENTOS DE DETALLE

- 1007-2** [x1] Boquilla
- 1286-D2-X** [x1] Casquillo en acero inoxidable
- 1286-D4-M0-X** [x1] Cabeza en acero inoxidable
- 1286-D4-M1-X** [x1] Cabeza en acero inoxidable
- 1349-108** [x1] Cuerpo
- R32** [x2] Unión
- S2** [x1] Junta

mod. MG1349

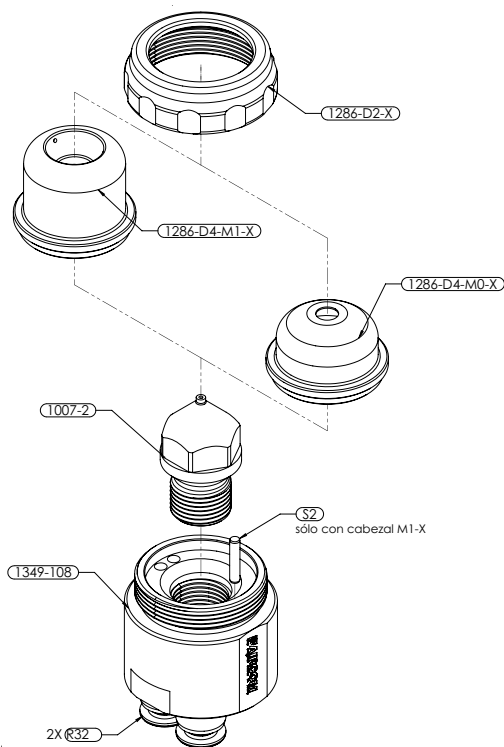



NOTA



Consulte la tabla CNN que aparece a continuación, para conocer las cabezas compatibles con su modelo.

CNN COMPATIBLES

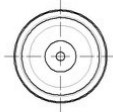
Cap-Nozzle-Needle

mod. MG

1286-D4-M0 ▲	CAP	NOZZLE	NEEDLE
 	1286-D4-M0-0.8	1007-2-0.8	1286-D5-0.8
	1286-D4-M0-1.0	1007-2-1.0	1286-D5-1.0
	1286-D4-M0-1.2	1007-2-1.2	1286-D5-1.2
	1286-D4-M0-1.5	1007-2-1.5	1286-D5-1.5

1286-D4-M1 ▲	CAP	NOZZLE	NEEDLE
 	1286-D4-M1-0.8	1007-2-0.8	1286-D5-0.8
	1286-D4-M1-1.0	1007-2-1.0	1286-D5-1.0
	1286-D4-M1-1.2	1007-2-1.2	1286-D5-1.2
	1286-D4-M1-1.5	1007-2-1.5	1286-D5-1.5



NOTE



- ▲ Cabeza en forma de cono
- ▲ Cabeza en forma de abanico

CNN COMPATIBLES

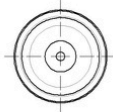
Cap-Nozzle-Needle

mod. MG1349

1286-D4-M0-X ▲	CAP	NOZZLE
 	1286-D4-M0-X-0.8	1007-2-0.8
	1286-D4-M0-X-1.0	1007-2-1.0
	1286-D4-M0-X-1.2	1007-2-1.2
	1286-D4-M0-X-1.5	1007-2-1.5

1286-D4-M1-X ▲	CAP	NOZZLE
 	1286-D4-M1-X-0.8	1007-2-0.8
	1286-D4-M1-X-1.0	1007-2-1.0
	1286-D4-M1-X-1.2	1007-2-1.2
	1286-D4-M1-X-1.5	1007-2-1.5

NOTE

- ▲ Cabeza en forma de cono
- ▲ Cabeza en forma de abanico

CALIDAD CERTIFICADA

CERTIFICACIONES

Todos los productos AIRCOM® se encuentran certificados de acuerdo con la norma EN 13 966 - 1 (VDMA-Einheitsblatt 24 366) y según los parámetros de eficiencia de transferencia.



SOPORTE

¿NECESITAS AYUDA?

Estamos a su disposición.



+39 0124 5154 44



aircom@aircom.it



Asistencia en línea

AIRCOM



DISCOVER ALL PRODUCTS



Follow us



aircom.it